



POWERING INNOVATION THAT DRIVES HUMAN ADVANCEMENT

© 2025 ANSYS, Inc. or its affiliated companies  
Unauthorized use, distribution, or duplication is prohibited.

## Getting Started with Icepak®: LTI ROM



ANSYS, Inc.  
Southpointe  
2600 Ansys Drive  
Canonsburg, PA 15317  
[ansysinfo@ansys.com](mailto:ansysinfo@ansys.com)  
<https://www.ansys.com>  
(T) 724-746-3304  
(F) 724-514-9494

Release 2025 R2  
July 2025

ANSYS, Inc. and  
ANSYS Europe,  
Ltd. are UL  
registered ISO  
9001:2015 com-  
panies.

## Copyright and Trademark Information

© 1986-2025 ANSYS, Inc. Unauthorized use, distribution or duplication is prohibited.

ANSYS, Ansys Workbench, AUTODYN, CFX, FLUENT and any and all ANSYS, Inc. brand, product, service and feature names, logos and slogans are registered trademarks or trademarks of ANSYS, Inc. or its subsidiaries located in the United States or other countries. Icem CFD is a trademark used by ANSYS, Inc. under license. All other brand, product, service and feature names or trademarks are the property of their respective owners. FLEXIm and FLEXnet are trademarks of Flexera Software LLC.

## Disclaimer Notice

THIS ANSYS SOFTWARE PRODUCT AND PROGRAM DOCUMENTATION INCLUDE TRADE SECRETS AND ARE CONFIDENTIAL AND PROPRIETARY PRODUCTS OF ANSYS, INC., ITS SUBSIDIARIES, OR LICENSORS. The software products and documentation are furnished by ANSYS, Inc., its subsidiaries, or affiliates under a software license agreement that contains provisions concerning non-disclosure, copying, length and nature of use, compliance with exporting laws, warranties, disclaimers, limitations of liability, and remedies, and other provisions. The software products and documentation may be used, disclosed, transferred, or copied only in accordance with the terms and conditions of that software license agreement.

ANSYS, Inc. and ANSYS Europe, Ltd. are UL registered ISO 9001: 2015 companies.

## U.S. Government Rights

For U.S. Government users, except as specifically granted by the ANSYS, Inc. software license agreement, the use, duplication, or disclosure by the United States Government is subject to restrictions stated in the ANSYS, Inc. software license agreement and FAR 12.212 (for non-DOD licenses).

## Third-Party Software

See the legal information in the product help files for the complete Legal Notice for Ansys proprietary software and third-party software. If you are unable to access the Legal Notice, please contact ANSYS, Inc.

## Conventions Used in this Guide

Please take a moment to review how instructions and other useful information are presented in this documentation.

- Procedures are presented as numbered lists. A single bullet indicates that the procedure has only one step.
- Bold type is used for the following:
  - Keyboard entries that should be typed in their entirety exactly as shown. For example, “**copy file1**” means you must type the word **copy**, then type a space, and then type **file1**.
  - On-screen prompts and messages, names of options and text boxes, and menu commands. Menu commands are often separated by greater than signs (>). For example, “click **HFSS > Excitations > Assign > Wave Port.**”
  - Labeled keys on the computer keyboard. For example, “Press **Enter**” means to press the key labeled **Enter**.
- Italic type is used for the following:
  - Emphasis.
  - The titles of publications.
  - Keyboard entries when a name or a variable must be typed in place of the words in italics. For example, “**copy filename**” means you must type the word **copy**, then type a space, and then type the name of the file.
- The plus sign (+) is used between keyboard keys to indicate that you should press the keys at the same time. For example, “Press Shift+F1” means to press the **Shift** key and, while holding it down, press the **F1** key also. You should always depress the modifier key or keys first (for example, Shift, Ctrl, Alt, or Ctrl+Shift), continue to hold it/them down, and then press the last key in the instruction.

**Accessing Commands:** *Ribbons*, *menu bars*, and *shortcut menus* are three methods that can be used to see what commands are available in the application.

- The *Ribbon* occupies the rectangular area at the top of the application window and contains multiple tabs. Each tab has relevant commands that are organized, grouped, and labeled. An example of a typical user interaction is as follows:

"Click **Draw > Line**"



This instruction means that you should click the **Line** command on the **Draw** ribbon tab. An image of the command icon, or a partial view of the ribbon, is often included with the instruction.

- The *menu bar* (located above the ribbon) is a group of the main commands of an application arranged by category such File, Edit, View, Project, etc. An example of a typical user interaction is as follows:

"On the **File** menu, click the **Open Examples** command" means you can click the **File** menu and then click **Open Examples** to launch the dialog box.

- Another alternative is to use the *shortcut menu* that appears when you click the right-mouse button. An example of a typical user interaction is as follows:

"Right-click and select **Assign Excitation> Wave Port**" means when you click the right-mouse button with an object face selected, you can execute the excitation commands from the shortcut menu (and the corresponding sub-menus).

## Getting Help: Ansys Technical Support

For information about Ansys Technical Support, go to the Ansys corporate Support website, <http://www.ansys.com/Support>. You can also contact your Ansys account manager in order to obtain this information.

All Ansys software files are ASCII text and can be sent conveniently by e-mail. When reporting difficulties, it is extremely helpful to include very specific information about what steps were taken or what stages the simulation reached, including software files as applicable. This allows more rapid and effective debugging.

## Help Menu

To access help from the Help menu, click **Help** and select from the menu:

- **[product name] Help** - opens the contents of the help. This help includes the help for the product and its *Getting Started Guides*.
- **[product name] Scripting Help** - opens the contents of the *Scripting Guide*.
- **[product name] Getting Started Guides** - opens a topic that contains links to Getting Started Guides in the help system.

## Context-Sensitive Help

To access help from the user interface, press **F1**. The help specific to the active product (design type) opens.

You can press **F1** while the cursor is pointing at a menu command or while a particular dialog box or dialog box tab is open. In this case, the help page associated with the command or open dialog box is displayed automatically.

# Table of Contents

<b>Table of Contents</b> .....	<b>Contents-1</b>
<b>1 - Introduction</b> .....	<b>1-1</b>
<b>2 - Prepare and Run the Icepak Parametric Trials</b> .....	<b>2-1</b>
Open the Project .....	2-1
Launch the Ansys Electronics Desktop .....	2-1
Set 3D UI Options .....	2-2
Assign Boundary Conditions .....	2-3
Create the LTI ROM Parametric Setup .....	2-5
Review the Toolkit Output .....	2-7
Run the Parametric Setup .....	2-12
Export the LTI ROM .....	2-13
<b>3 - Prepare and Run the Twin Builder Analysis</b> .....	<b>3-1</b>
Run Thermal Model Identification .....	3-1
Build the Twin Builder Model .....	3-3
Place the ROM in Twin Builder .....	3-3
Enable Outputs .....	3-5
Specify Inputs .....	3-5
Place Source and Time Function Blocks .....	3-5
Specify Input Parameters .....	3-7
Run the Analysis and Plot the Outputs .....	3-8
Specify Settings and Run the Analysis .....	3-8
Plot the Outputs .....	3-9



# 1 - Introduction

This document is intended as supplementary material to Icepak for beginners and advanced users. It includes instructions to create and use a Reduced Order Model (ROM) using Ansys Icepak and Ansys Twin Builder.

There are two steps to create ROM model:

- Create the step response files. These files can be created automatically using Icepak. This tutorial demonstrates how to create the required step response files in Icepak.
- Create the ROM in Twin Builder. This tutorial also presents the procedure needed to create a state-space model in Twin Builder.

This chapter contains the following topic:

- "Sample Project" below

## Sample Project

In this project, we have four FET's (Field-effect transistor) placed on a board and a heat sink mounted on one of the FET. These FET's generate heat which gets dissipated into the environment. Forced convection is used for thermal management of the system.

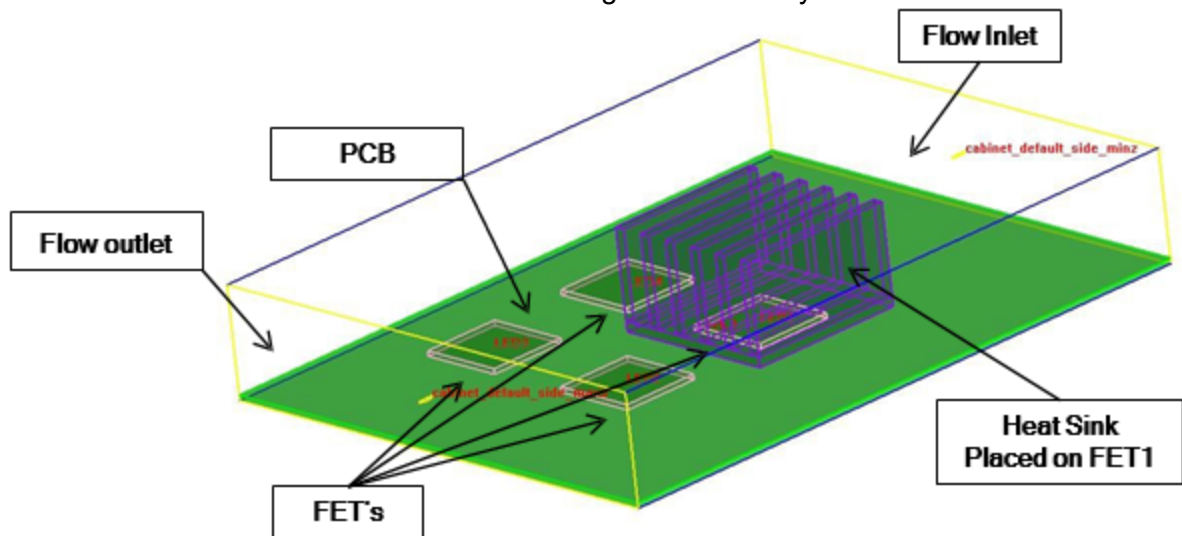

**Figure 1-1: Sample Project**

We are interested in temperature rise at the four FET's due to its power dissipation. From a system point of view, power dissipation from the FET's are the inputs and the temperature rise at the four FET's are the outputs. We will create a ROM which can efficiently calculate temperatures at the pre defined outputs under any transient heat dissipation scenario.

The state-space approach is generally valid for linear systems consisting of forced convection flow and insignificant radiative heat transfer.



## 2 - Prepare and Run the Icepak Parametric Trials

This chapter contains the following topics:

- [Open the Project](#)
- [Assign Boundary Conditions](#)
- [Create the LTI ROM Parametric Setup](#)
- [Review the Toolkit Output](#)
- [Run the Parametric Setup](#)
- [Export the LTI ROM](#)



### Open the Project

This chapter contains the following topics:

- Launch the Ansys Electronics Desktop
- Set 3D UI Options

### Launch the Ansys Electronics Desktop

A shortcut of the Ansys Electronics Desktop application appears on your desktop once the application is installed.

1. On the **Desktop** ribbon tab, click  **Open Examples**. Then:
  - a. In the *Open* dialog box that appears, click the parent folder icon () once to move up one level above the *Examples* folder.
  - b. Double-click the **Help** folder and then the **Icepak** folder.
  - c. Select the file **Icepak\_TwinBuilder.aedt** and click **Open**.
2. The model is displayed in the **3D Modeler** window.

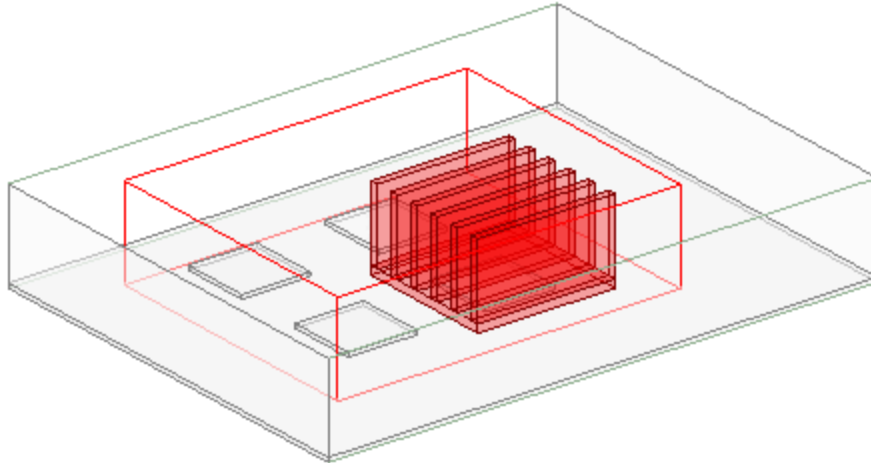

**Figure 2-1: Field-effect transistors model in the 3D Modeler window**

3. From the **File** menu, select **Save As**, and save the project in the desired working directory.

## Set 3D UI Options

Ensure that the new view orientation scheme introduced in release 2024 R1 is not being used, since the instructions and images in this guide are based on the legacy orientation scheme.

1. From the menu bar, click **View > Options**.  
The *3D UI Options* dialog box appears.
2. Ensure that **Enable Legacy View Orientation** is enabled:

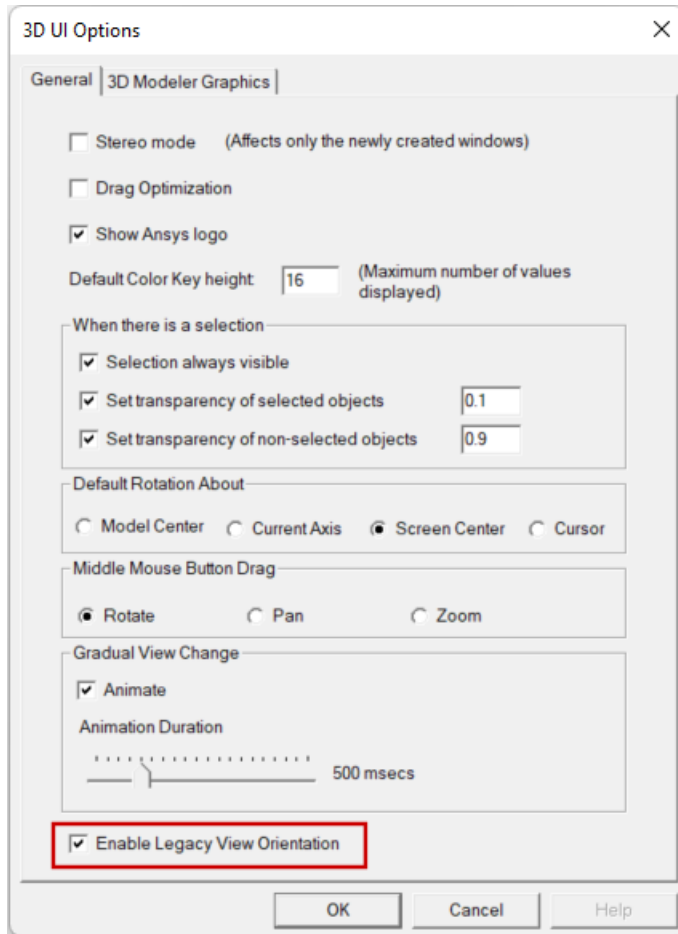

3. Click **OK**.

## Assign Boundary Conditions

Assign block thermal boundary conditions to the FET objects.

1. In the History tree, right-click on FET1 and select **Assign Thermal > Block**.

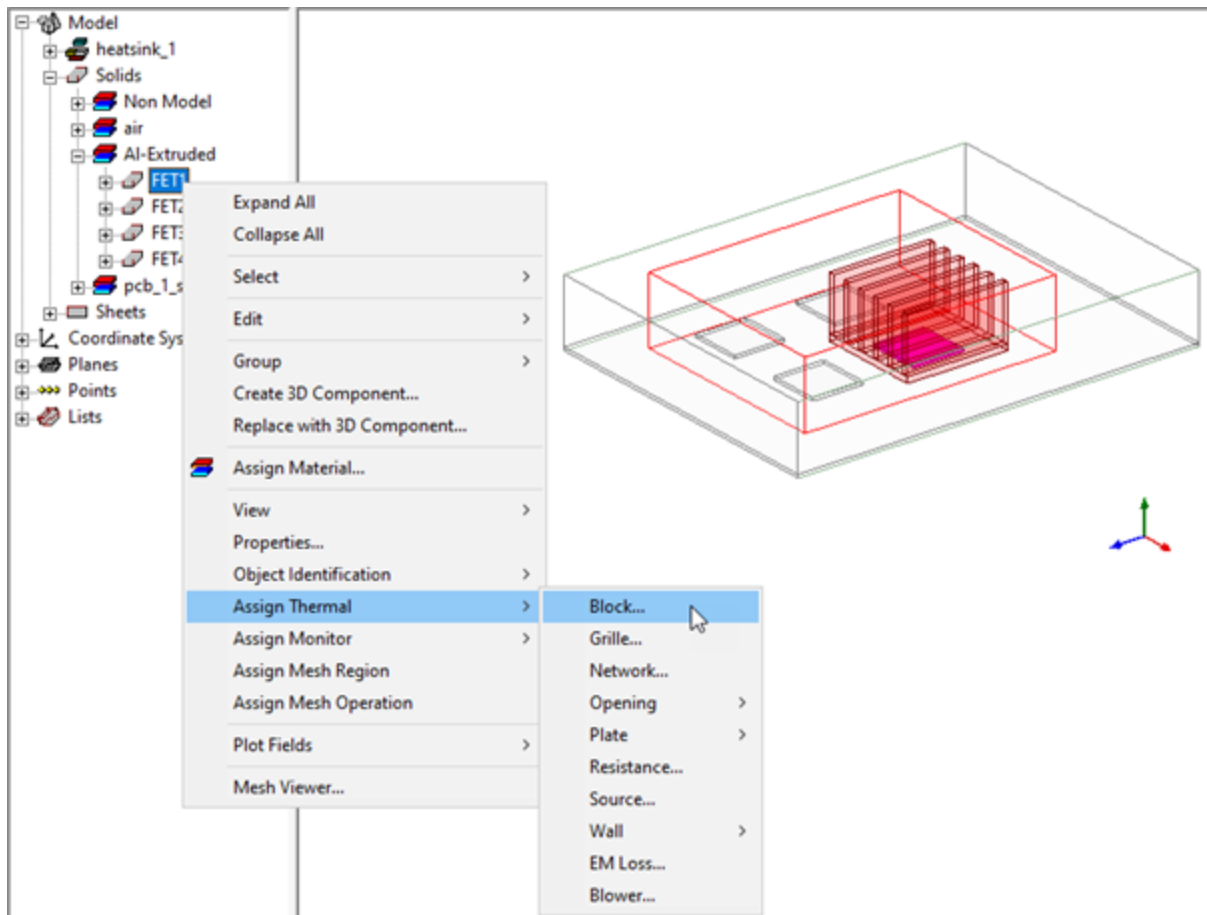

2. In the **Block Thermal Model** dialog box, enter **FET1** for the **Name**.
3. Retain the default settings and click **OK**.
4. Repeat steps 1 through 3 for FET2, FET3, and FET4, naming the boundary conditions accordingly. The boundary condition assignments appear under **Thermal** in the **Project Manager**.

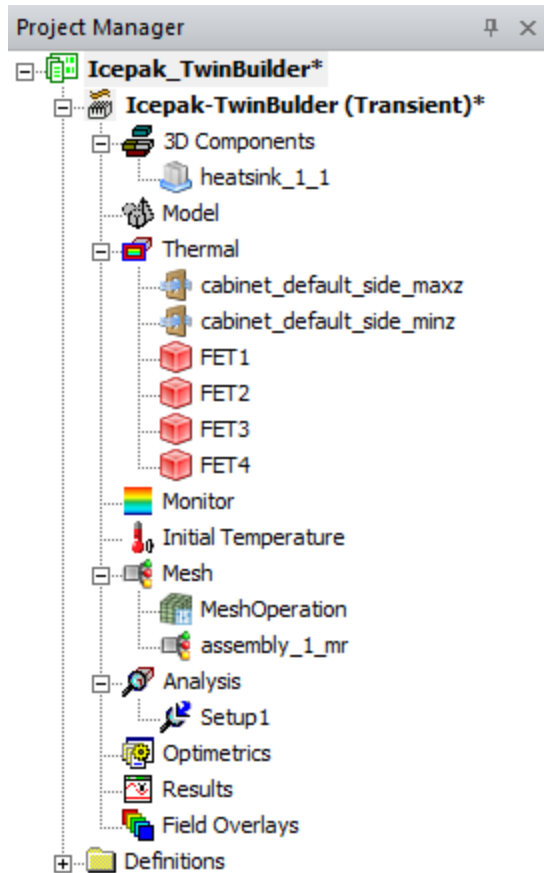

## Create the LTI ROM Parametric Setup

Run the LTI ROM Parametric Setup toolkit to generate the parametric trials.

1. From the **Icepak > Toolkit > Modeling** menu, select **LTI\_ROM\_Parametric\_Setup**.
2. In the **LTI ROM Parametric Setup** dialog box, do the following:
  - Note the default **Input** and **Output** selections.
  - Note the design's solution setup is already selected in the **Select Transient Setup** drop-down list.
  - Select **Create steady state design and link with transient setup**.
  - For **Input Object Power**, retain the default 5W power value.
  - Click **Create Setup**. The toolkit generates the LTI ROM output.

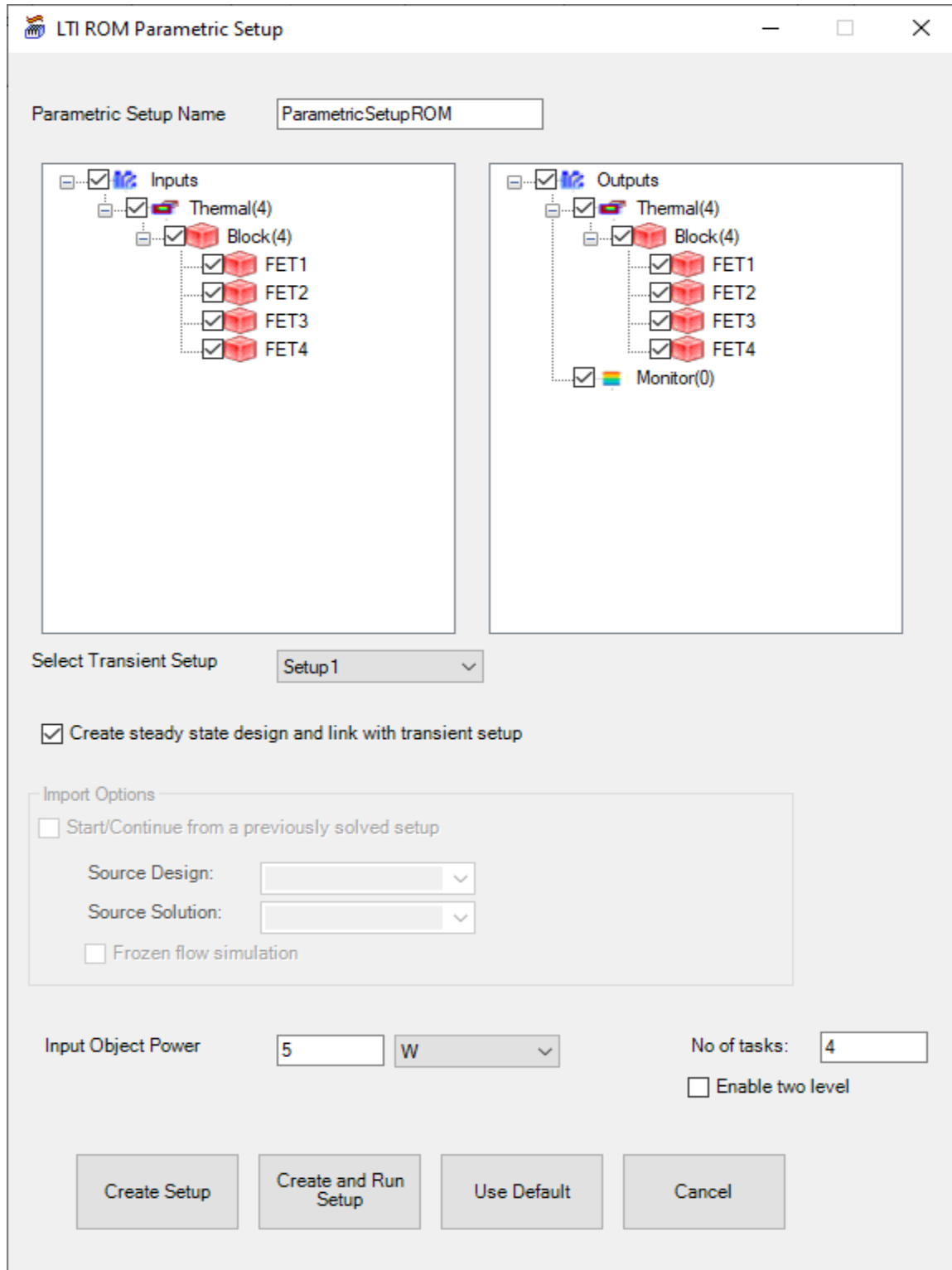

## Review the Toolkit Output

Review the project items generated by the LTI ROM Parametric Setup toolkit.

1. In the **Project Manager**, note that the steady state design with the corresponding boundary conditions has been added to the project.

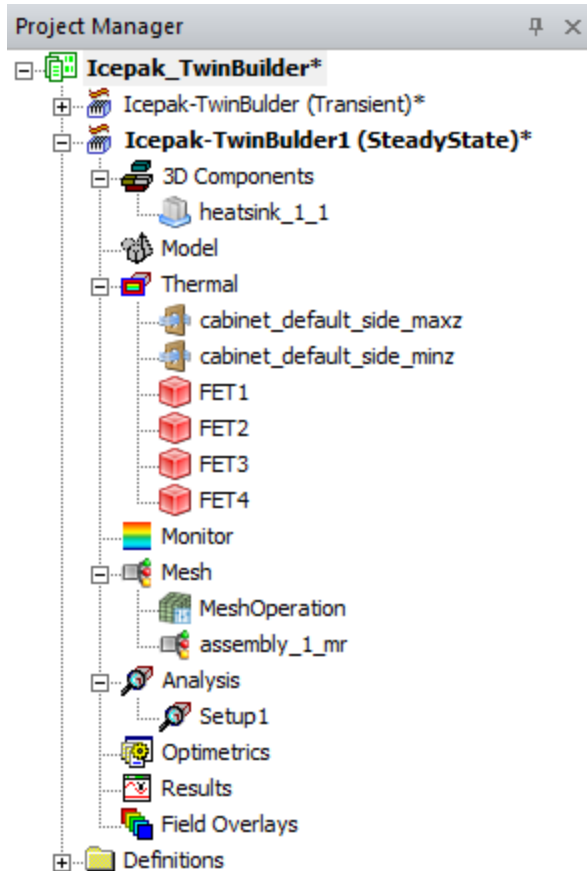

2. In the original transient design, note that block boundary conditions' **Total Power** values are now assigned a variable.

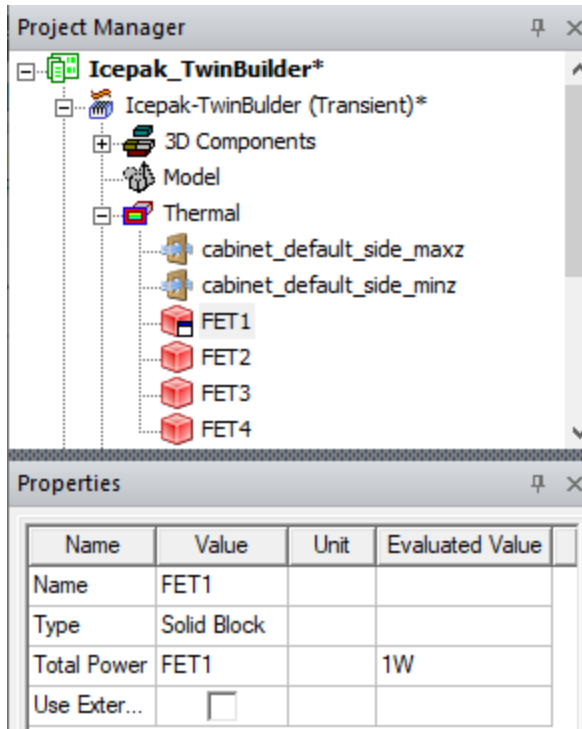

3. Note that monitor points have been added under **Monitor**.

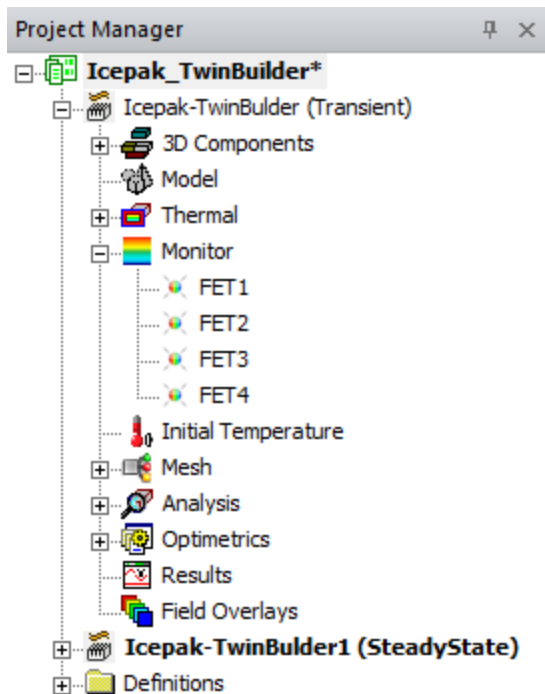

4. In the transient design, expand **Analysis** and double-click **Setup1**. The solve setup has been set to run the transient from 0 to 10000 seconds.

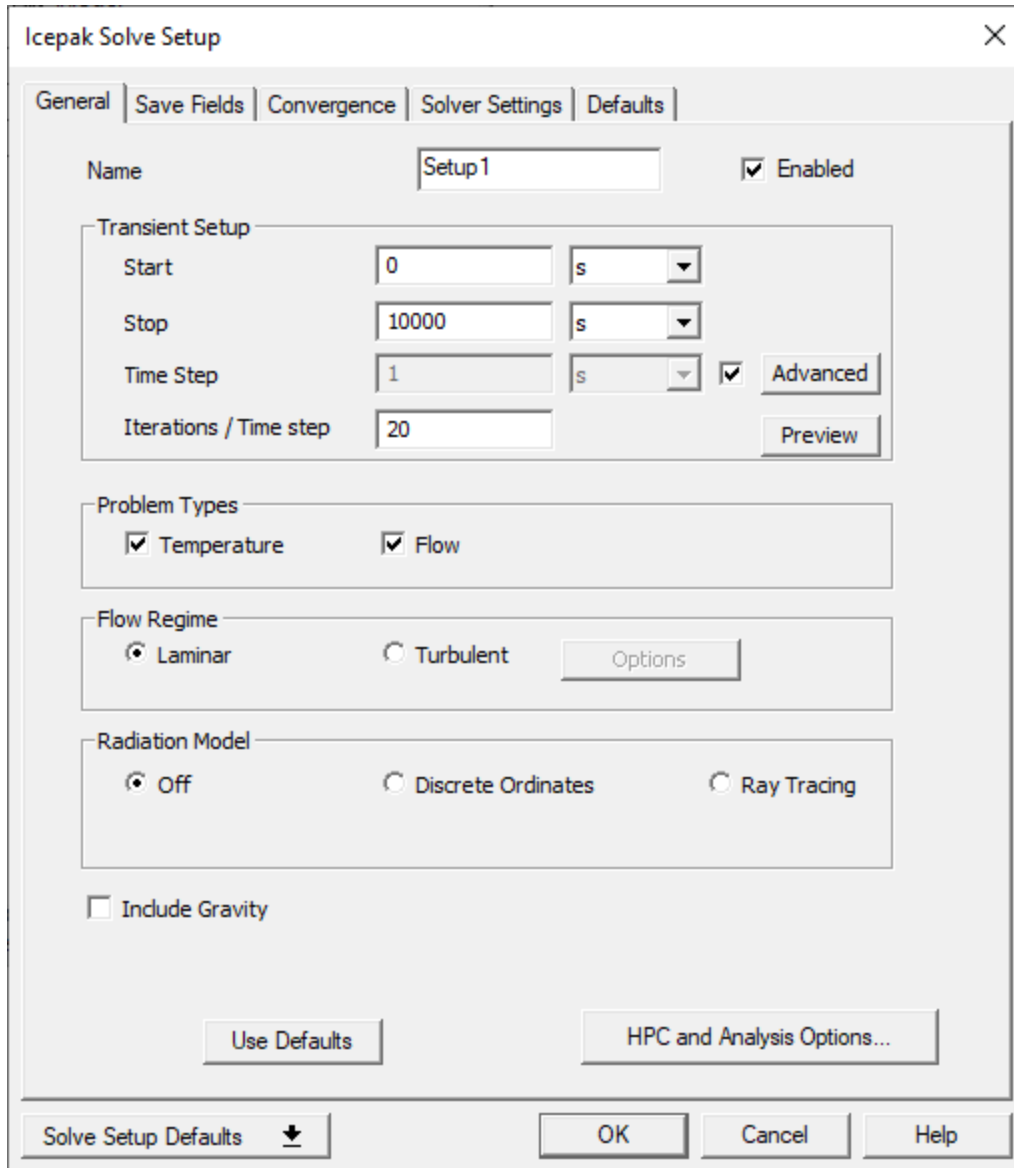

5. Click **Advanced** next to **Time Step**. The toolkit generated a dataset and assigned it as the piecewise constant variation function. As time increases, the time step size increases, so fewer steps are run as time progresses in the transient simulation.

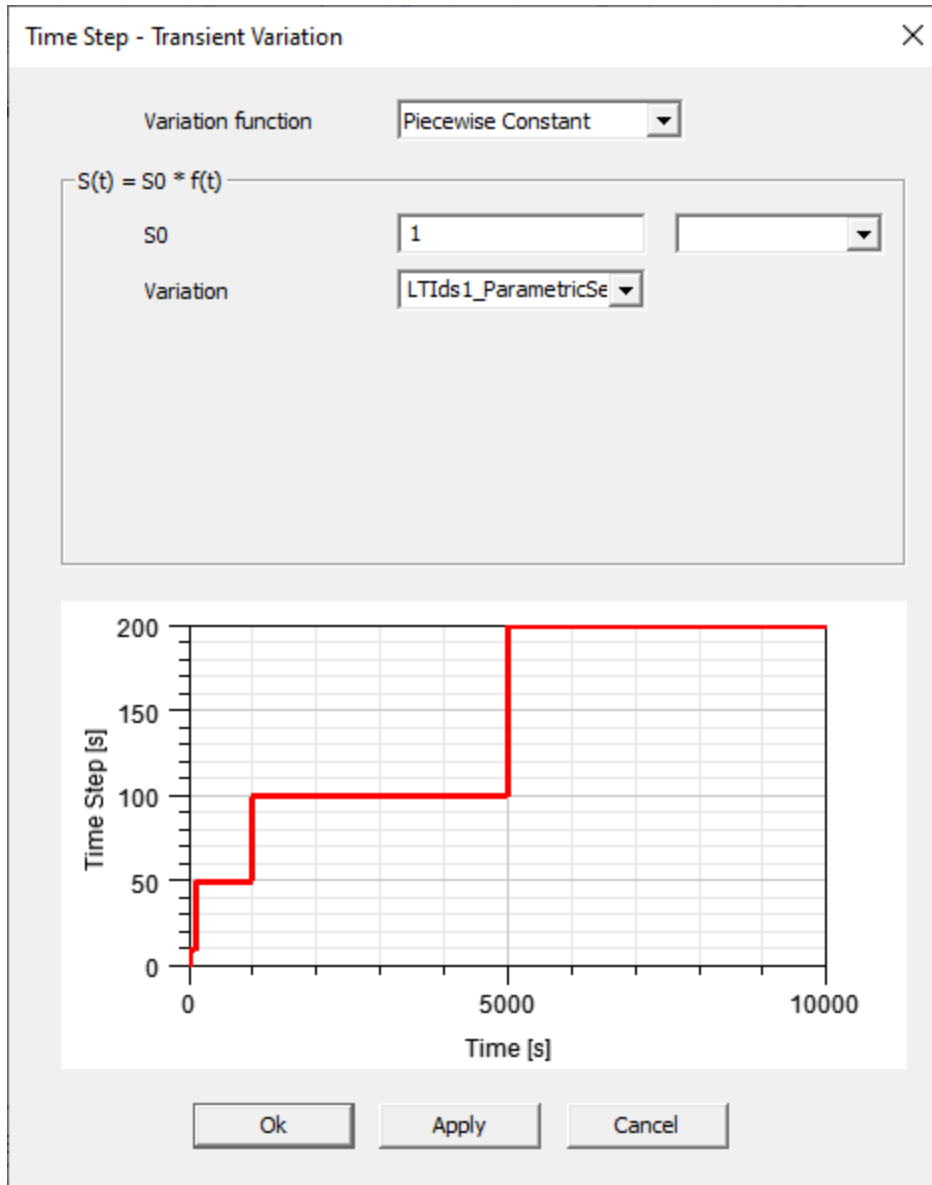

6. On the **Solver Settings** tab, the toolkit enabled the **Start/Continue from a previously solved setup** and **Frozen flow simulation** check boxes and linked to the steady state design.

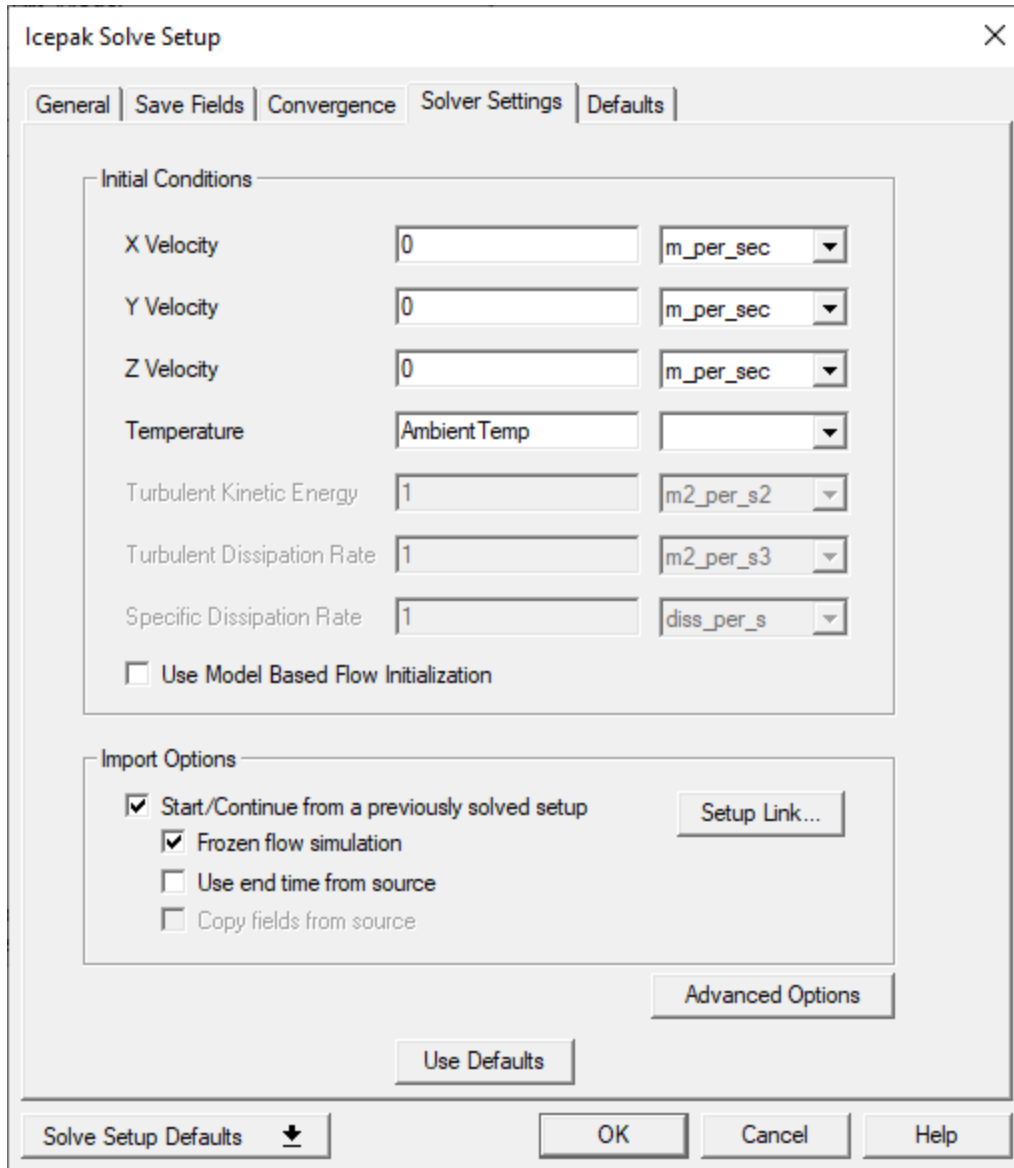

7. In the **Project Manager** under **Optimetrics**, the toolkit added the parametric metric setup. Double-click **ParametricSetupROM**. In the **Setup Sweet Analysis** dialog box **Table** tab, note the four trials with one field-effect transistor assigned 5W total power value for each trial.

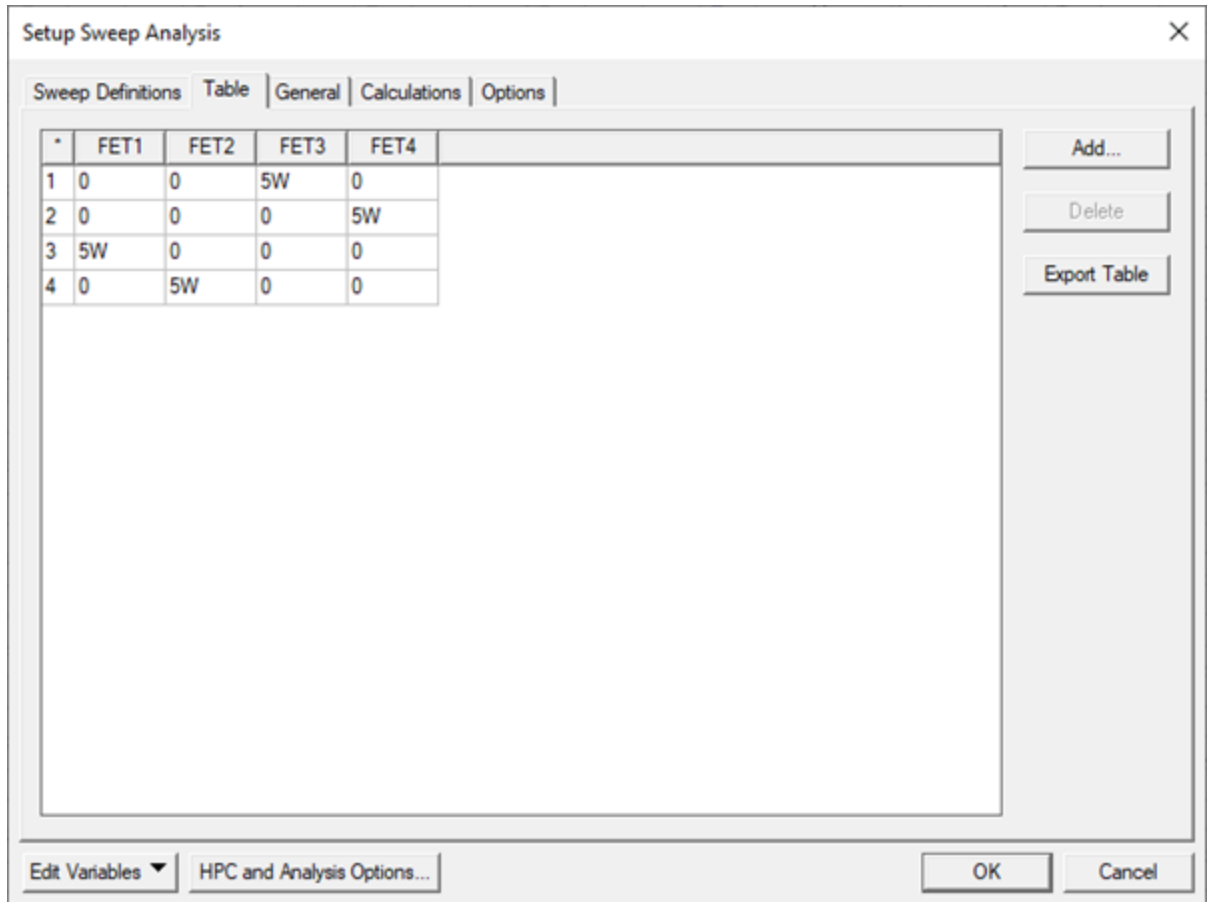

## Run the Parametric Setup

1. In the **Project Manager** under **Optimetrics**, right-click **ParametricSetupROM** and select **Analyze**.
2. In the **Project Manager** under **Analysis**, right-click **Setup1** and select **Thermal Monitor** to display the temperature results.
3. In the **Solutions** dialog box, click the **Design Variation [...]** button.

4. In the **Set Design Variation**, select a row and click **OK** to plot the monitor point data.

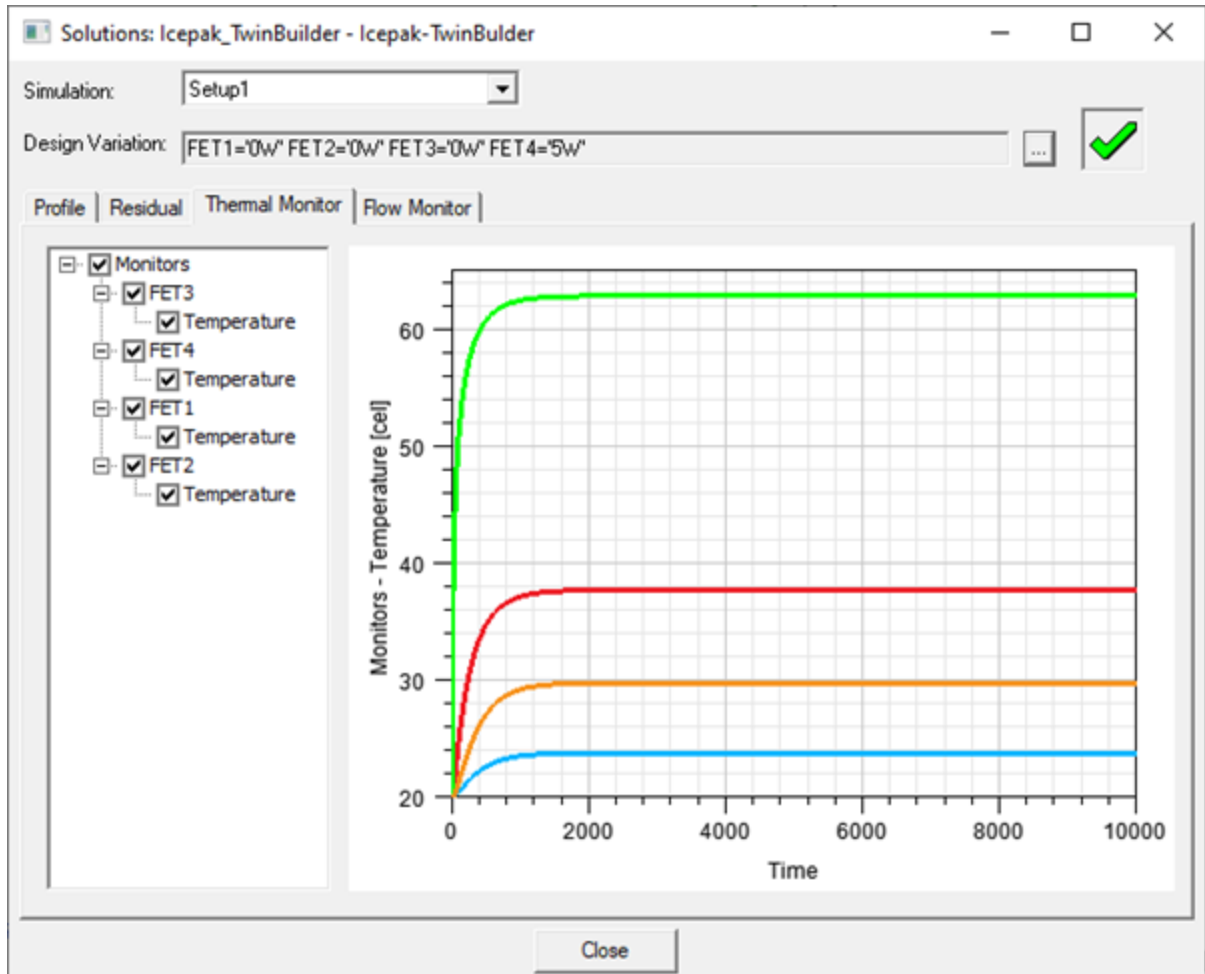

## Export the LTI ROM

1. From the **Icepak** menu, select **Export ROM > LTI ROM**.
2. In the **Export LTI ROM** dialog box, note the default selections.

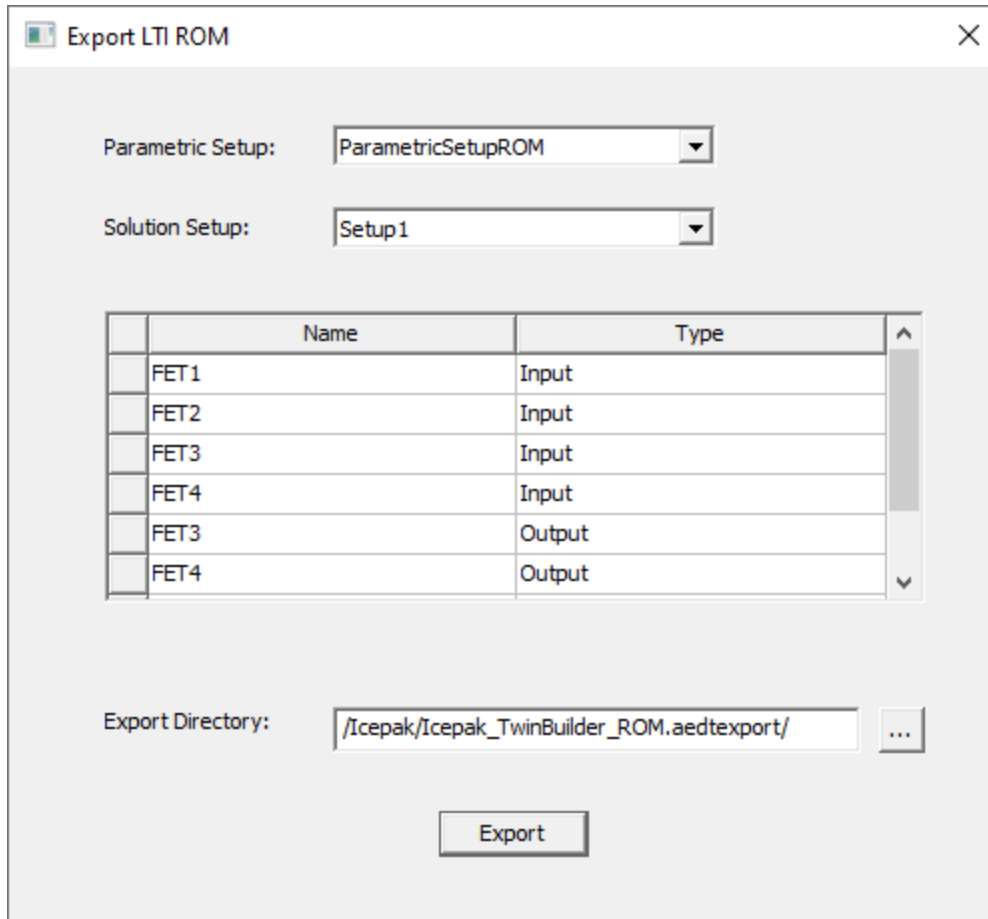

3. If needed, select a different **Export Directory**.
4. Click **Export** to export the solutions. This completes the generation of the step response data using Icepak. In the next section you will use the step response data to create a state-space model in Twin Builder.

## 3 - Prepare and Run the Twin Builder Analysis

This chapter contains the following topics:

- [Run Thermal Model Identification](#)
- [Build the Twin Builder Model](#)
- [Run the Analysis and Plot the Outputs](#)

### Run Thermal Model Identification

In Twin Builder, create a ROM model from the Icepak data.

1. From the **Project** menu, select **Insert Simplorer Design**.
2. From the **Twin Builder** menu, select **Toolkit > Thermal Model Identification**.
3. In the **Thermal Model Identification** dialog box, do the following:
  - **Number of Inputs:** Enter 4.
  - **Number of Outputs:** Enter 4.
  - **Response/Input File Location:** Click **Browse** and select the directory in which you exported the data from Icepak. The directory is appended with `_TwinBuilderFiles`.

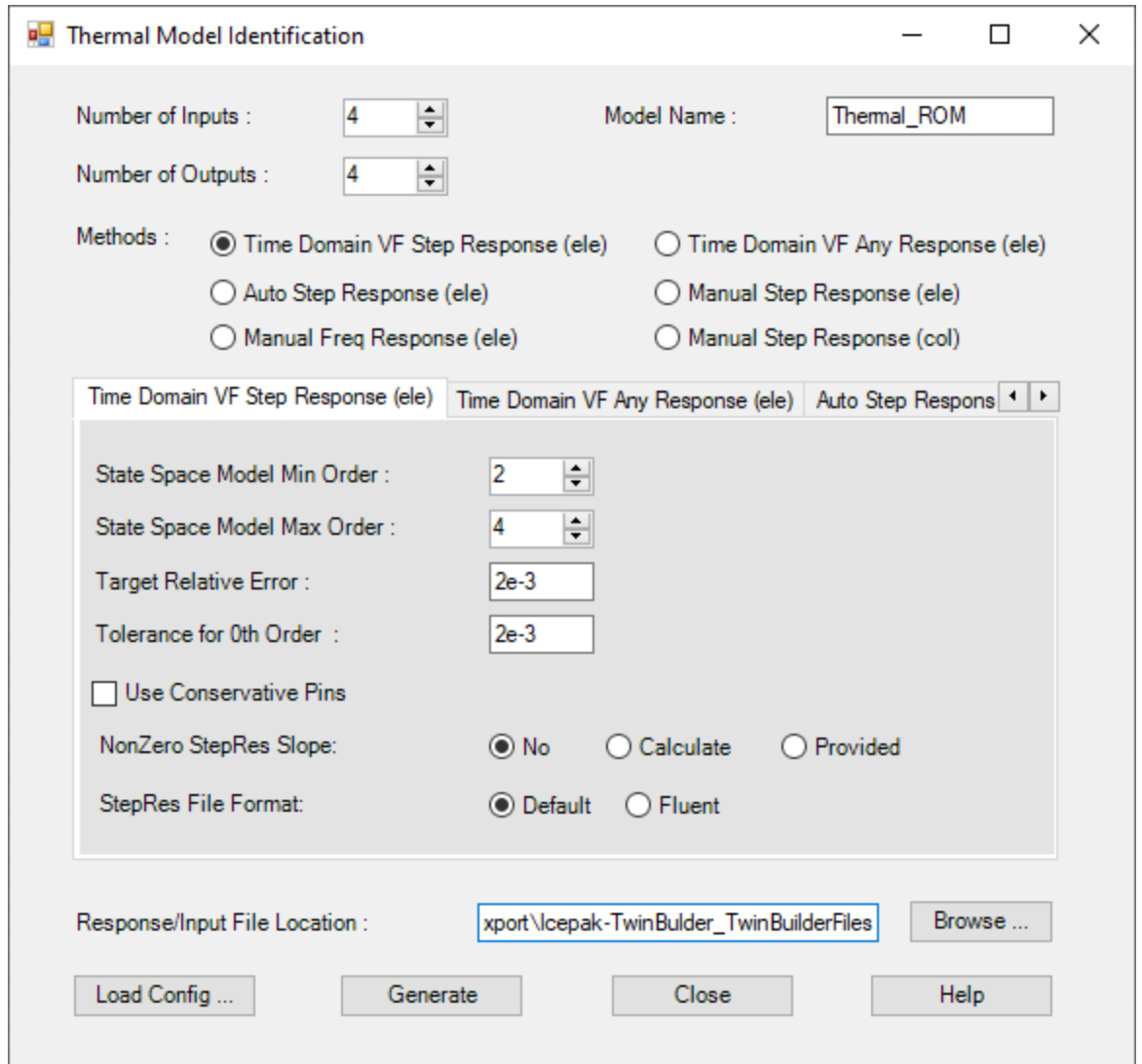

- Click **Generate**.
4. A command prompt appears. Press any key to continue to generate the ROM model.

```

C:\Program Files\AnsysEM\v222\Win64\FittingTool.exe
Input 4, FET4, on output 3, FET1.
-----
Input 4, FET4, on output 4, FET2.
-----
[INFO] Final Order Matrix :
2      2      4      4
2      2      4      4
4      2      2      2
2      4      2      2
-----
[INFO] Fitting error matrix in time domain:
4 4
8.508462e-04  1.446026e-03  6.782757e-04  2.781384e-04
1.616028e-03  1.180681e-03  2.684487e-04  7.700219e-04
1.221714e-03  1.641996e-03  8.947886e-04  1.639931e-03
1.479218e-03  7.414178e-04  1.402640e-03  1.337718e-03
-----
[INFO] An LTI ROM has been generated. This can be loaded into Twin Builder for calculation.
Press any key to continue . . .

```

5. In the **Complete** dialog box, click **OK**.

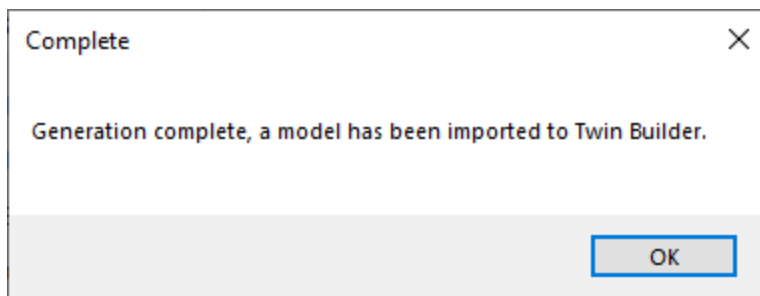

6. In the **Thermal Model Identification** dialog box, click **Close**.

## Build the Twin Builder Model

Insert the thermal ROM component and build the model.

## Place the ROM in Twin Builder

1. In the **Project Manager**, double-click the **Simplorer1** design to ensure it is the active design.
2. Expand **Definitions > Components**.

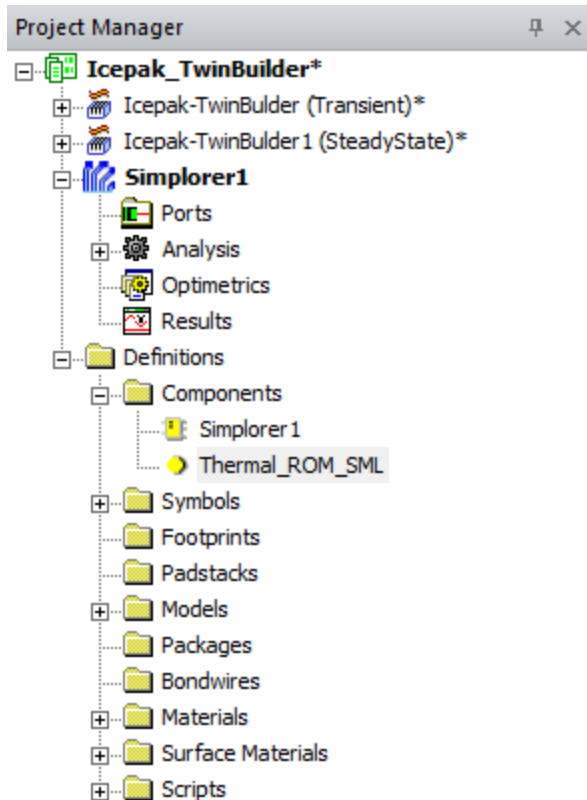

3. Select **Thermal\_ROM\_SML** and drag it into the **3D Modeler** window. Click again to place the component and the press **Esc** to exist the component placement mode.

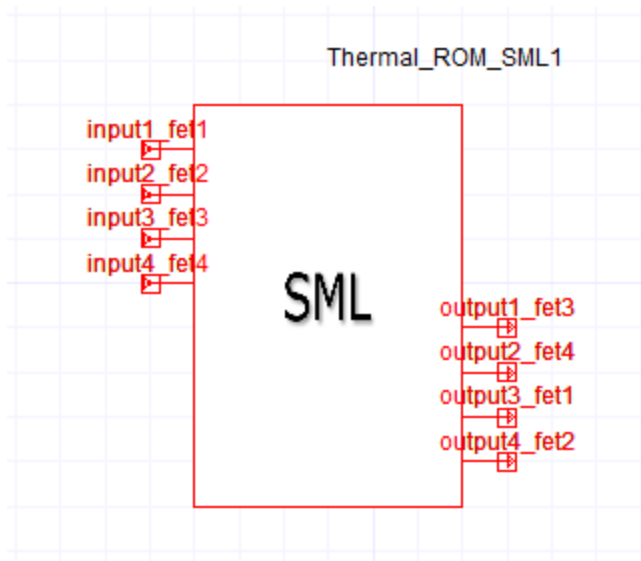

## Enable Outputs

1. From the **Twin Builder** menu, select **Output Dialog**.
2. In the **Output Dialog**, expand **Thermal\_ROM\_SML1** and select the four outputs listed.

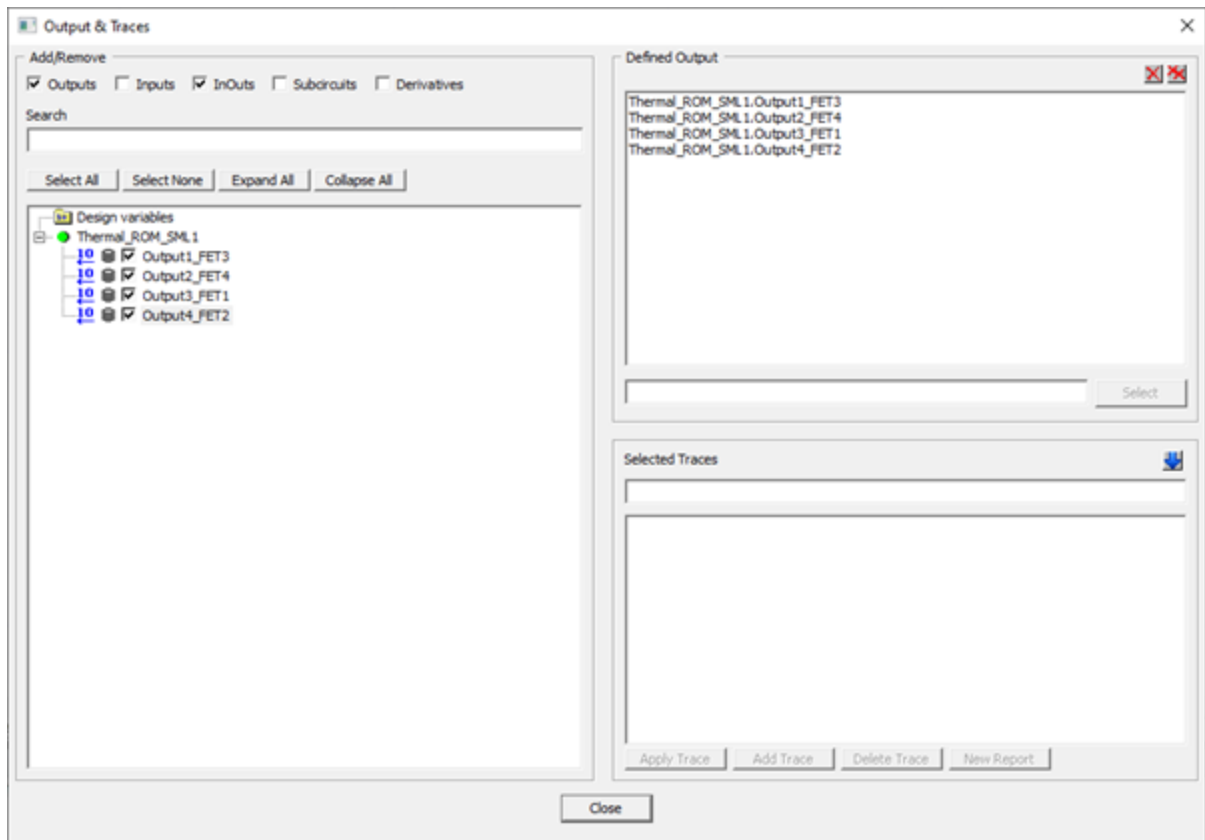

3. Click **Close**.

## Specify Inputs

### Place Source and Time Function Blocks

#### Note:

If the **Component Libraries** window is not displayed, click **View > Component Libraries**.

1. On the **Components** tab of the **Component Libraries** window, expand **Simplorer Elements > Basic Elements > Blocks > Sources Blocks**.
2. Click and drag **CONST: Constant Value** to the workspace. Click again to place the block.

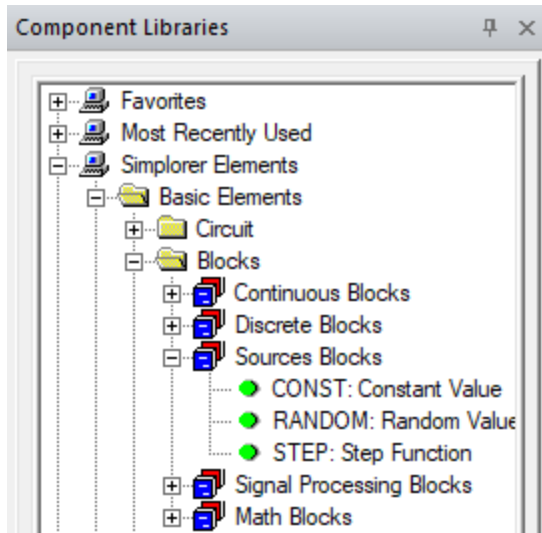

3. Place two more **CONST: Constant Value** blocks in the workspace.
4. Press **Esc** to exit placement mode.
5. Connect the blocks to the inputs as displayed in the following image.

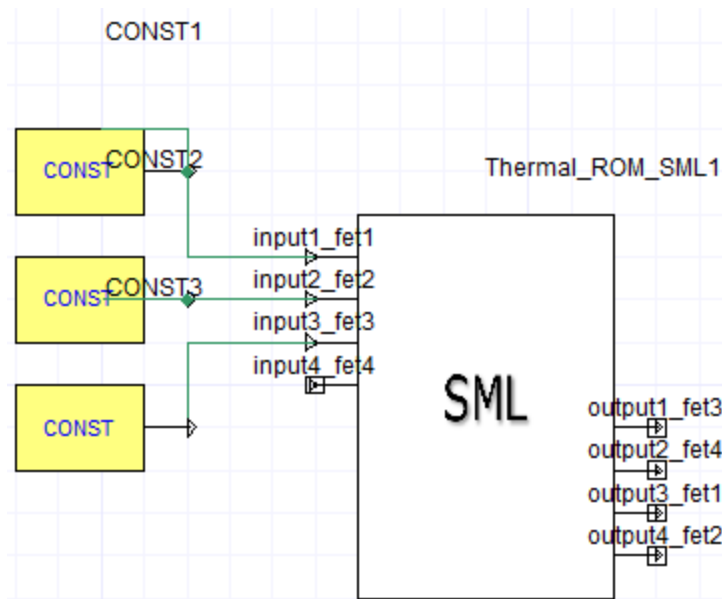

6. In the **Component Libraries** window, expand **Simplorer Elements > Basic Elements > Tools > Time Functions**.
7. Click and drag **TRAPEZ: Trapezoidal Wave** to the workspace. Release the mouse button to place the block.
8. Connect the block to input4\_fet4.

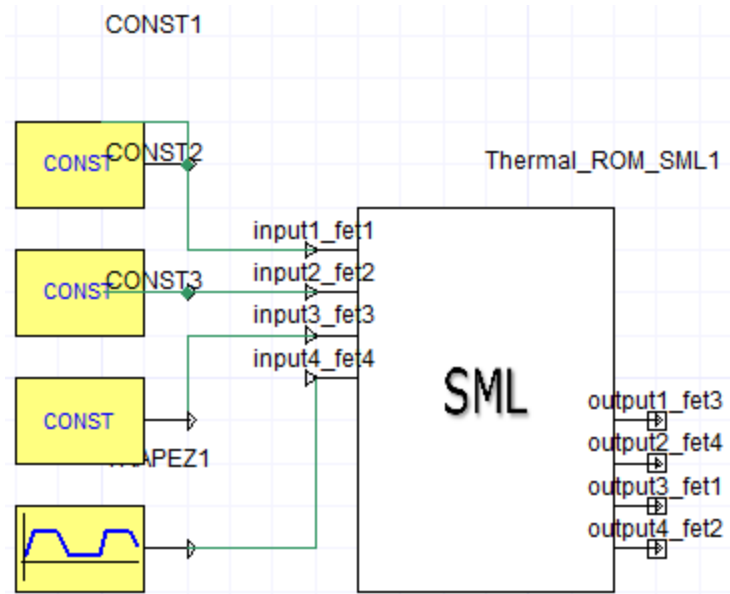

## Specify Input Parameters

1. Double-click the **CONST1** block to open its **Parameters** panel.
2. Under **Parameters** next to **Value**, enter 1.5 to specify the power dissipation (in Watts) for the ROM and click **OK**.

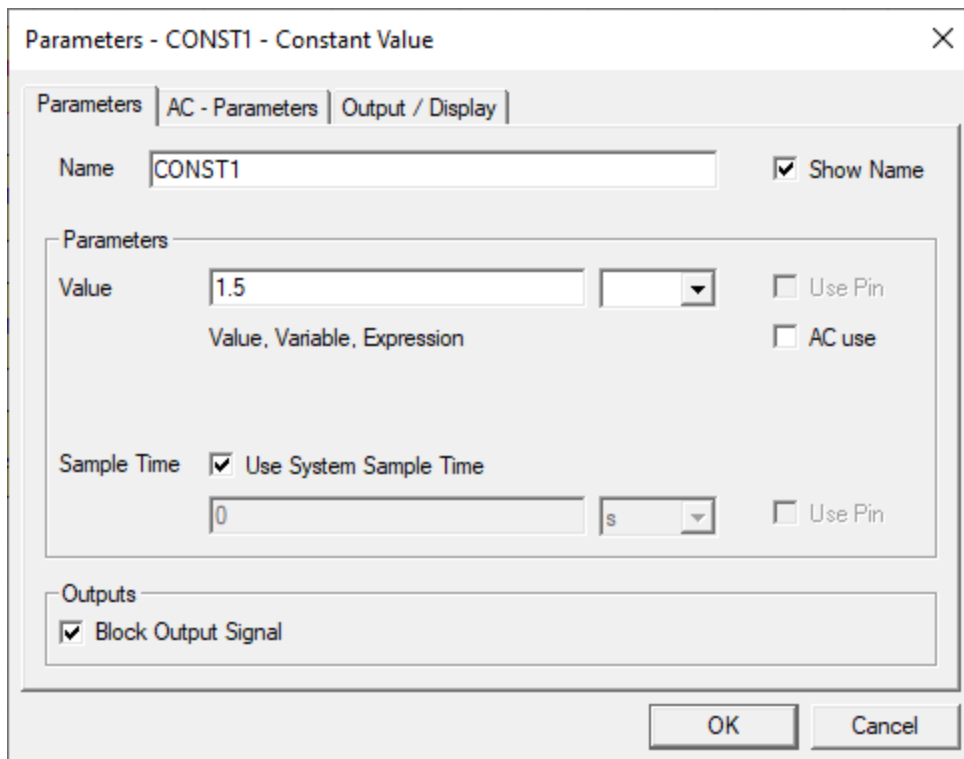

3. Repeat Step 2 for **CONST2** and **CONST3**.
4. Double-click the **TRAPEZ1** block to open its **Parameters** panel. Enter the values as displayed in the following image.

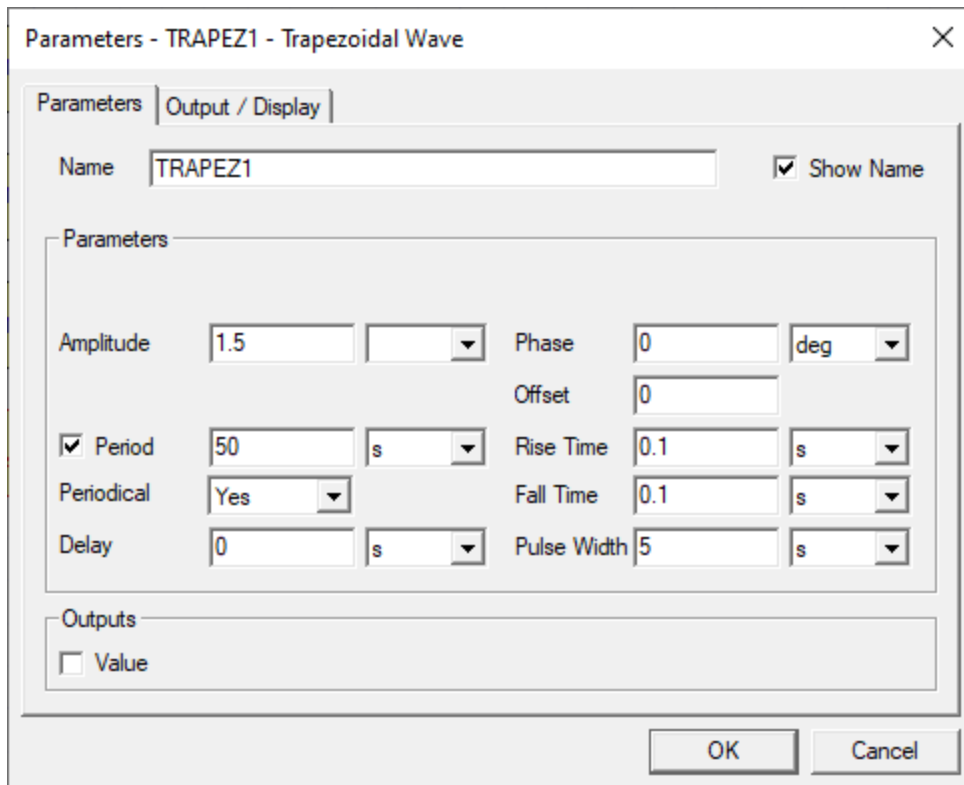

## Run the Analysis and Plot the Outputs

### Specify Settings and Run the Analysis

1. In the **Project Manager**, expand **Analysis**.
2. Double-click on **TR** solution setup.
3. In the **Transient Setup Analysis** dialog box, do the following:
  - **End Time - Tend**: Enter 1000 s.
  - **Min Time Step - Hmin**: Enter 0.1 s.
  - **Max Time Step - Hmax**: Enter 4 s.

#### Note:

Ensure that you select seconds as the unit for the three entries.

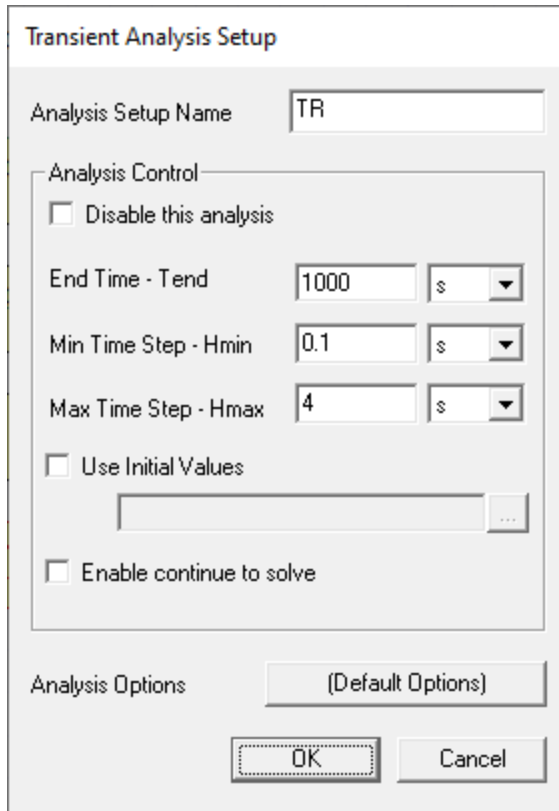

4. Click **OK**.
5. Right-click the **TR** solution setup and select **Analyze**.

## Plot the Outputs

1. In the **Project Manager**, right-click **Results** and select **Create Standard Report > Rectangular Plot**.
2. In the **Report** dialog box, select all four outputs as shown in the image below.

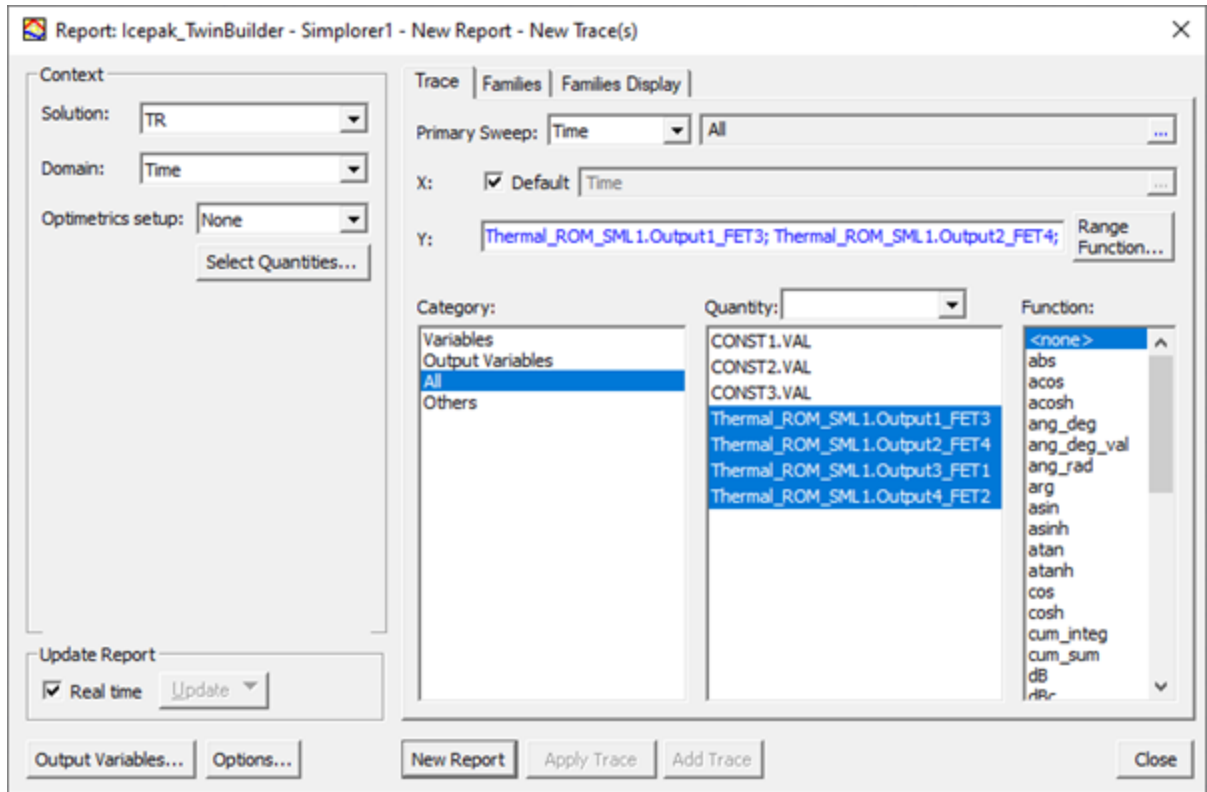

3. Click **New Report** and then **Close**.

